

Robust, weather-resistant telephone

ResistTel



Operating instructions



Our weather-resistant telephone is a captivating product on account of its precision, convenience, long service life and reliability. It is freely programmable and the optimum choice for adverse ambient conditions. Be it seawater, high atmospheric humidity, dust or the toughest mechanical strains, the weather-resistant telephone accomplishes its aim in any conditions. The reason for this is the robust keypad made of V4A steel and an extremely solid housing made of impact-resistant and shockproof cast-moulding material. All of the components utilised are even resistant to leeches and lubricants. The 21-component V4A-steel keypad - which can be operated by a user wearing gloves - and the easily readable alphanumeric display as well as the uncomplicated menus all ensure simple operation - thus fulfilling the requirements for a leading-edge and operationally reliable means of communication. As a telephone suitable for connecting to the public telephone network and to private automatic branch exchanges, the ResistTel always ensures reliable connections.

ResistTel ZB is designed for telephone exchange operation and corresponds to the ResistTel, except for keypad and display.

Table of contents

General operating instructions	4
Overview of the device	5
Display and keyboard	8
Contents after unpacking	9
ZB version notes	9
Assembly and installation	10
Connection diagram	11
Sling holder	11
Drilling diagram	11
Handset mode	13
Open listening	13
Hands-free talking	13
Working with the headset	14
Menu	15
Main Menu	16
Submenu: Telephone Book	17
Submenu: Change Telephone Book	18
Submenu: Lock / PIN	19
Submenu: Settings	20
Submenu: Languages	21
Default Settings	21
Menu overview	22
Technical data	23
Guidelines and regulations	26
Service	27
Maintenance and servicing	27
Waste disposal	27
Warning and safety instructions	27
CE symbol	28
Index of catchwords	29

General operating instructions

1. Both the weather-resistant ResistTel telephone and the ZB version are designed for connection to dial ports with analogue connection points.
2. The handset is fitted with a stray-field coil for connecting hearing-aids. People who use hearing-aids which have an inductive receiver can receive the earphone signal directly.
3. The optional, external loudspeaker has three operating modes – calling/ringing, open listening and hands-free. If the external loudspeaker is switched on, the internal loudspeaker volume will be reduced.
4. The ZB version is not equipped with keypad and display, therefore not all the features are available with this version.
5. The ResistTel has a handset module with a dry reed contact as a hook switch. In order to terminate an existing call connection, the handset must be hung up. In order to interrupt an existing call connection, it is sufficient to press the clearing key on the keypad.(see page 8)
6. Use the menu to program the appropriate settings. To access the menu, pick up the handset and press the "YES" key.
7. If you take longer than 2 minutes before you begin making a choice, the power supply of the exchange may be switched off. If that occurs, you will no longer hear a dialling tone. In that case, please replace the handset and wait 2 seconds before picking it up again.
8. When a setting is stored successfully, this is confirmed by an acknowledgement tone.
9. When you receive a call, the ResistTel rings at the ringer-volume level selected by you and, for the duration of the calling sound, the symbols ((())) appears on the display.
10. If you enter a PIN with the menu you can restrict or block dial functions. Forgetting the PIN is the equivalent of losing a key. If you forget the PIN, please contact our technical support.
11. You have a guarantee period of 24 months commencing from the date of purchase. If you have a problem, please contact our technical support in Germany, located in Mülheim an der Ruhr:

Telephone: 0208 8268 102 · Fax: 0208 8268 377
e-mail: info@fhf.de

From outside of Germany, please prefix the country code:
Telephone: +49 208 8268 102 · Fax: +49 208 8268 377

If a fault occurs which cannot be rectified by telephone, please send the whole telephone along with a copy of the sales receipt to the following address:

FHF
Support ResistTel
Gewerbeallee 15-19
D-45478 Mülheim an der Ruhr
Germany

If, on examination of the telephone, it is discovered that a fault is not the case, you will be charged a service fee.

Overview of the device

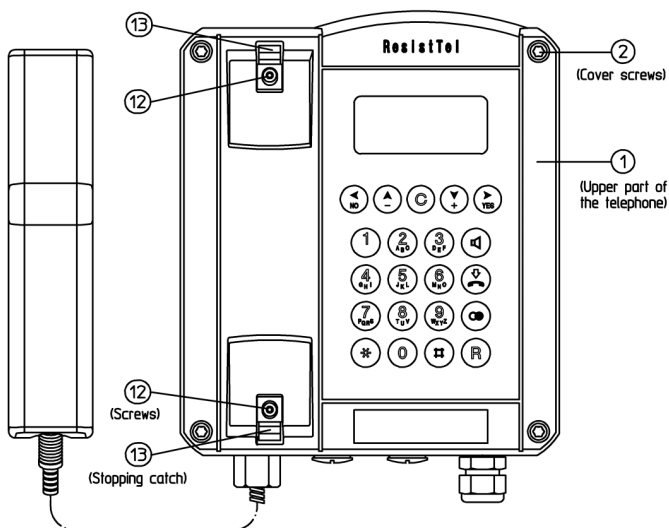

Note: In case of the ZB version, the keypad and display are replaced by a solid metal plate.

Outside view of telephone lower part

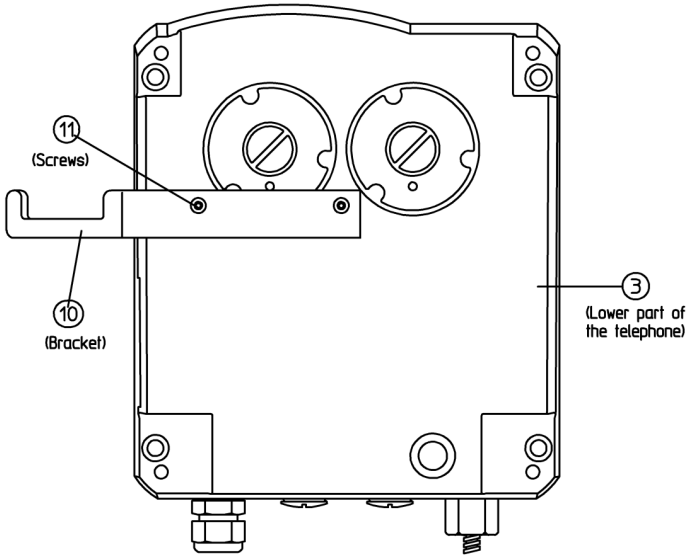

Inside view of telephone upper part

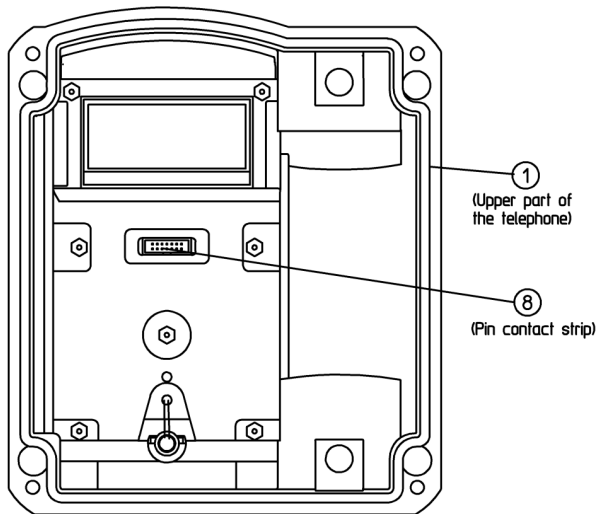

Note: The ZB version is not equipped with a pin contact strip.

Inside view of telephone lower part

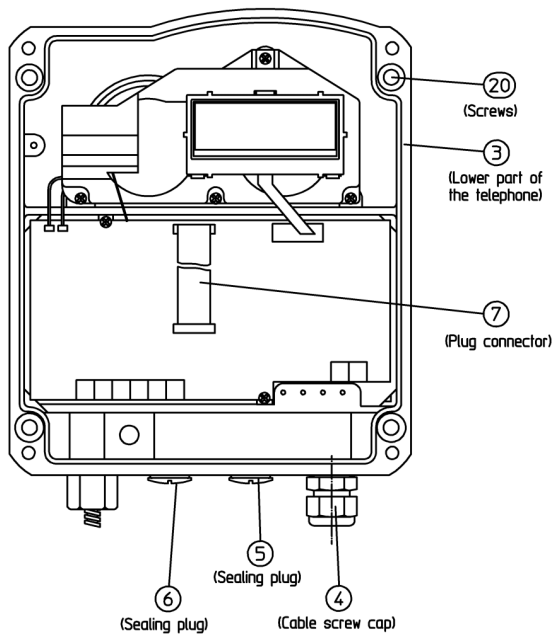

Note: The ZB version is neither equipped with a plug connector nor a display.

Function keys

Using these keys, you can directly change settings or make durable settings in the menu.

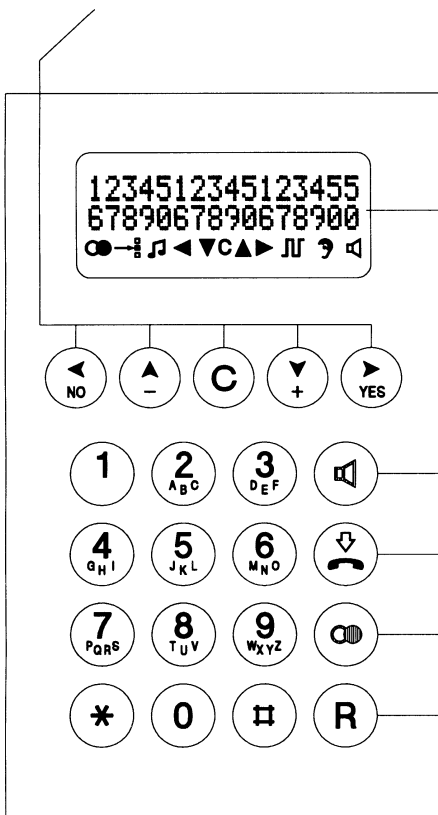

Display

The upper two lines display the call number or the menu settings. The lower line shows appropriate pictograms for the functions.

Switching key

Open listening or hands-free talking

Clearing key

Repeat dialling key

Consultation hold key

Number keys

These keys are used to enter call numbers and texts.

Contents after unpacking

The delivery includes:

- ResistTel telephone
- Operating instructions
- 2 self-adhesive lettering plates

ZB version notes

The ResistTel / ZB connects – depending on the features of the PABX – with the PABX while lifting the handset. The ResistTel / ZB can be called also, because the ringing circuit is built in.

Furthermore there are interfaces for operating an optional additional earpiece, an optional secondary ringer and an optional external loudspeaker.

The operating mode „external loudspeaker“ is set up by bridging the terminals 9 and 10 (HSS1,HSS2). With the ZB version this is equivalent to the open listening mode. The ringer sound is also output via the external loudspeaker.

Note:

The set up of the external loudspeaker reduces the volume of the internal ringer even if the external loudspeaker is not connected.

Thus the ZB version offers the following features:

- Establishing a connection by lifting up the receiver
- Ringing by means of integrated ringing device
- Connection of additional earpiece
- Connection of secondary ringer
- Connection of external loudspeaker

The device must be installed on a plane surface only, in vertical operating position. Loosen the cover screws (2) (see overview of the device on page 5 to 7). and detach the upper part of the telephone (1). If the optional accessory headset or a second ear piece is being employed, attach the bracket (10) using two screws (11) to the rear panel of the lower part of the telephone. (With the accessories named before, the bracket and screws are in the scope of delivery. With all accessories a cable gland is delivered.) Plug the lower part of the telephone (3) into the opening (20) using four screws having a head diameter of 10 to 13 mm and attach it to the wall or to a holder.

Guide the telephone wire through the cable screw cap (4) and place it on the terminals 13 and 14 (A, B) in accordance with the connection diagram. Only wires having a sheath diameter of 5 to 9 mm should be used because otherwise the IP66 housing protection standard is not guaranteed.

Connecting a second ringer (bell-shunt) (optional accessory)

Remove the sealing plug (5) and tighten the M20x1.5 cable gland cap. Insert the wire of the second ringer and place it on the terminals in accordance with of the connection diagram. Only utilise wires which have a sheath diameter of 5 to 9 mm because otherwise the IP66 housing protection standard is not guaranteed.

Connecting an external loudspeaker (optional accessory)

Remove the sealing plug (6) and tighten the M20x1.5 cable gland cap. Insert the wire of the loudspeaker and place it on the terminals 11 and 12 (SPK+, SPK-) in accordance with the connection diagram. Only utilise wires which have a sheath diameter of 5 to 9 mm because otherwise the IP66 housing protection standard is not guaranteed.

Connecting a headset (optional accessory)

Remove the sealing plug (6) and tighten the M20x1.5 cable gland cap. Guide the specially-manufactured wire with the headset socket (included in the delivery of the headset) through the cable screw cap and place it on the terminals 5 through 10 (HSM+, HSM-, HSR+, HSR-, HSS1, HSS2) in accordance with the connection diagram. Only the wire included in the delivery for the headset should be used because otherwise the IP66 housing protection standard is not guaranteed.

Connecting a second ear piece (optional accessory)

Remove the sealing plug (6) and tighten the M20x1.5 cable gland cap. Insert the wire of the second ear piece and place it on the terminals 7 and 8 (HSR+, HSR-) in accordance with the connection diagram.

Prior to assembly, check cover seal for tightness.

Using the plug connector (7), plug the ribbon cable onto the pin contact strip (8) in the upper part of the housing.

Attach the upper part of the telephone and fasten it to the lower part of the telephone with the four cover screws (2).

Upon disassembly of optional accessories, suited blind plugs must be used to close the resulting openings.

Connection diagram

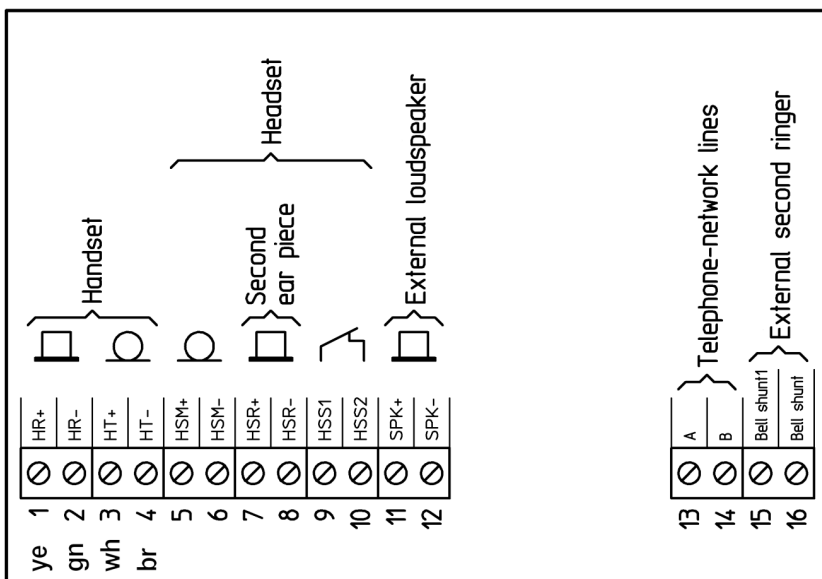

Sling holder

The holding strength for the handset is continuously adjustable.

Loosen the screws (12) and move the stopping catches (13). Pushing the stopping catches together increases the holding strength whereas pulling them apart reduces it. Tighten the screws again.



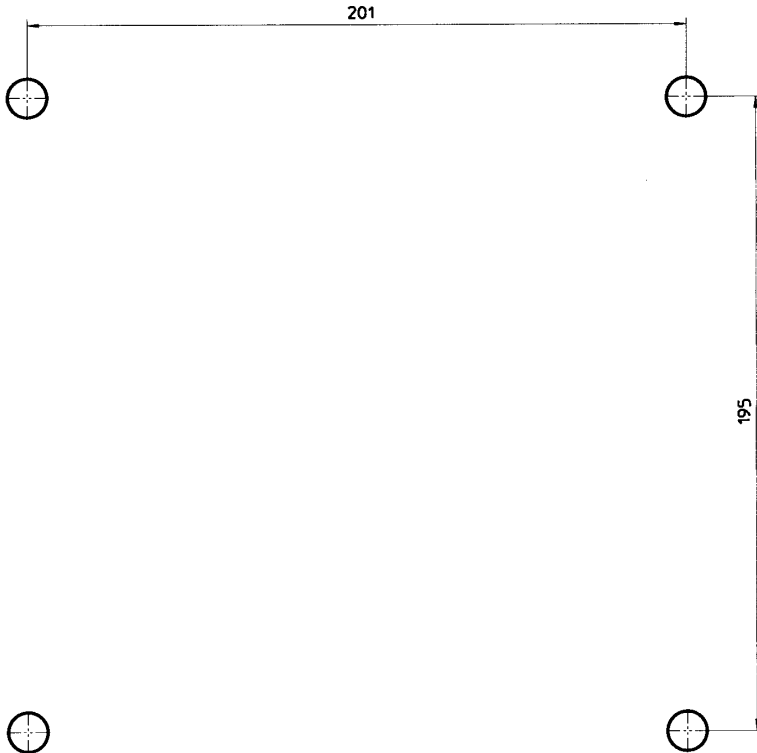

Drilling diagram

For making a drilling template please use the following dimensions (in mm).







The diameter of the drilled hole is dependent on the screw employed (screw diameter max. 8 mm) and the type of supporting base material (steel, wood, concrete, plasterboard etc.) and must be chosen accordingly.





Handset mode (except ZB version)

When you pick up the handset, you are in handset mode. Using the keys  and , you can adjust the handset volume for talking. If you wish to durably change the handset volume, use the menu "Settings / Handset volume". Using the key  you can switch into open listening mode. If you keep the key  depressed and replace the handset, you switch to hands-free talking mode.

Open Listening mode (except ZB version)

Using the keys  and , you can adjust the loudspeaker volume for talking. If you wish to change the loudspeaker volume durably, use the menu "Settings / Loudspeaker". The handset volume cannot be changed in open listening mode. Using the key , you can switch to handset mode. If you keep the key  depressed and replace the handset, you switch to hands-free-talking mode.

Hands-free mode (except ZB version)



If you switch on the ResistTel using the key  you are in hands-free-talking mode. Using the keys  and  you can adjust the loudspeaker volume for talking. If you wish to durably change the loudspeaker volume, use the menu "Settings / Loudspeaker". You end the call using the key . If you pick up the handset, you switch to handset mode.

Working with the headset (except ZB version)

If the headset has been connected correctly, it takes the place of hands-free talking. For this reason, hands-free talking with the headset is not possible. If you switch on the ResistTel with the key , you are operating in headset mode. If you lift the handset while in headset mode, the handset assumes a higher priority. That means that it is possible to speak and listen using the handset but, in this mode, it is only possible to listen with the headset.

Comparison of the operating states without and with connected headset:

Operation without the headset	Operation with the headset
<u>Handset mode</u>	<u>Handset mode with the headset</u> <ul style="list-style-type: none">- Handset can speak and listen- Headset can only listen- Loudspeaker is off
<u>Open Listening mode</u>	<u>Open Listening with the headset</u> <ul style="list-style-type: none">- Handset can speak and listen- Headset can only listen- Loudspeaker is on
<u>Hands-free mode</u>	<u>Headset mode</u> <ul style="list-style-type: none">- Handset is replaced- Headset can speak and listen- Loudspeaker is off

Using the keys  and  you can adjust the headset volume for talking. If you wish to durably change the headset volume, use the menu "Settings / Headset Volume". You end the call using the key .

Menu (except ZB version)

Starting the menu

Press the key .

You are now situated in the main menu.

The top line of the display indicates the menu in which you are located.

The lower line indicates which menu item is selected.

Selecting menu items

Press the key  or .

The upper line of the display remains unchanged. In the lower line, the menu items available for selection change with each key-press.

Activating a menu item

Press the key .

The menu item which was indicated in the lower line is now located in the upper line. In the lower line, you see the additional options available.

Exiting the menu



Press the key .

With each key-press, you jump to the previous menu. When you arrive back in the main menu, you exit it with the next key-press .

Main Menu (except ZB version)



With the aid of the key  or , you can make selections under the following items:

- Telephone Book For selecting a telephone number from the telephone book memory.
- Change Phonebook For creating new telephone book entries
For modifying existing telephone book entries
For deleting existing telephone book entries
- Lock / PIN For changing to the submenu Direct call
For setting the complete lock
To permit selections from the telephone book only
For disabling or enabling the main menu items "Settings", "Languages" and "Change Phonebook"
For changing the PIN
- Settings For adjusting the ringer volume and changing the melody
Adjust the loudspeaker volume
Adjust the handset volume
Adjust the headset volume
Adjust the LCD contrast
Set the dialling method
Set the flash time
Set the exchange number and pause
Restoring to the default dettings
Switch on/off an external loudspeaker
Welcome text
- Languages For selecting the menu language German
For selecting the menu language English
For selecting the menu language Spanish
For selecting the menu language French
For selecting the menu language Italian

When you select an item, you can activate it with the key . You can exit the menu with the key .



Submenu - Telephone Book (except ZB version)

You have the option of dialling up to 50 telephone numbers from the telephone book. To store and/or change numbers, see the menu item "Change telephone book".

You can select from the telephone book entries using the key  or .

Examples:



- FIRE BRIGADE 999 dials the telephone number shown on the display
- SECURITY 110 dials the telephone number shown on the display
- FHF MUELHEIM 020882680 dials the telephone number shown on the display
- CANTEEN 123 dials the telephone number shown on the display
- etc. dials the telephone number shown on the display

When you have selected a telephone number to call, you can dial it by pressing the key . You can exit the menu using the key .



Submenu - Change Telephone Book (except ZB version)

You can store up to 50 telephone numbers and their associated names. Enter the numbers and names in their order of importance because they later appear on the display in the order in which they were entered (e.g. fire brigade before canteen).

Caution: The menu item "Default Settings" deletes all telephone book entries.

With the aid of the key  or , you can make selections under the following items:

- New Entry To make a new entry
- Change Entry To change an entry
- Delete Entry To delete an entry
- Delete All To delete the entire telephone book

When you have selected an item, you can activate it by pressing the key . You can exit the menu using the key .

Submenu - Lock / PIN (except ZB version)

When you call up the menu "Lock / PIN", you are prompted to enter the PIN. The PIN consists of 4 digits. In the state when delivered, the PIN is "0 0 0 0".

If you change the PIN, don't forget the new PIN. Forgetting the PIN is the equivalent of losing a key. If you forget the PIN, please contact our technical support.

Technical support in Germany, located in Mülheim an der Ruhr:

Telephone 0208 8268 102



Fax 0208 8268 377

e-mail info@fhf.de



From outside of Germany, please prefix the country code:

Telephone +49 208 8268 102

Fax +49 208 8268 377

When you have entered the PIN, you can make selections under the following items with the aid of the key  or  :

- Direct Call To switch on the direct call
To enter the direct call number
- Total Lock Locks the telephone preventing all outgoing calls
Caution: It is also not possible to dial emergency telephone numbers
- Directory Only Only permits outgoing calls to numbers contained in telephone book
- Settings For disabling or enabling the main menu items "Settings", "Languages" and "Change Phonebook"
- Change PIN To change the PIN

When you have selected an item, you can activate it by pressing the key . You can exit the menu using the key .

Note:

When the settings are disabled the main menu items "Settings", "Languages" and "Change Phonebook" are only accessible after entering the PIN.

The menu item "Default Settings" resets all settings except, however, the PIN you may have changed and the language.

Submenu - Settings (except ZB version)

With the aid of the key  or , you can make selections under the following items:

- Ringer
 - For setting the ringer volume
 - For setting the ringer melody
- Speaker Volume
 - For setting the loudspeaker volume
- Handset Volume
 - For setting the handset volume
- Headset Volume
 - For setting the headset volume
- LCD Contrast
 - For setting the display contrast
- Dialling
 - Dialling method DTMF/ duration 90 ms
 - Dialling method Pulse Dial 2:1
 - Dialling method Pulse Dial 1.5:1
 - Dialling method DTMF / duration 70 ms
 - Dialling method DTMF / duration = keypress
- Flash time
 - Set the flash time, 40 ms to 399 ms
- PABX Settings
 - Entry of the exchange number
 - Deletion of the exchange number
 - Setting the dialling pause after the exchange number
- Defaults
 - Reset to the state when delivered
- External Speaker
 - Switch on/off an external loudspeaker

Note:



The optional, external loudspeaker has three operating modes callig/ringing, open listening and hands-free. If it is switched on, the internal loudspeaker volume will be reduced.

- Welcome text
 - input of an individual text, which is indicated in the display after taking off the handset.



For example:

BRANCH 170
EXTERNAL DEPOT



When you have selected an item, you can activate it by pressing the key

 . You can exit the menu using the key  .

Submenu - Languages (except ZB version)

You can make selections under the following items with the aid of the key  or  :

- German For setting the menu language to German
- English For setting the menu language to English
- Spanish For setting the menu language to Spanish
- French For setting the menu language to French
- Italian For setting the menu language to Italian

When you have selected an item, you can activate it by pressing the key . You can exit the menu using the key .

Default Settings

To enable you to use the telephone immediately after connecting it, we have made default settings for general utilisation purposes. Using the menu, you can alter these default values in accordance with your own personal necessities and connection requirements.

Upon delivery of the telephone, the following default values are set:

- Telephone book: deleted
- Repeat dialling: deleted
- Direct call number: deleted
- Exchange number: deleted
- Ringer melody: 0
- Ringer volume: 6 (maximum value)
- Handset volume: 0 (normal value)
- Headset volume: 2
- Loudspeaker volume: 4
- External loudspeaker: switched off
- Welcome text FHF
- Dialling method: DTMF, signal duration 90 ms
- Flash time: 80 ms
- LCD contrast: 5 (normal value)
- Pause length after exchange number: 3 seconds
- PIN: 0000

Caution!

Resetting to the default settings via the menu restores these default values with the exception of the PIN and the language:

- The PIN is not changed.
- The language is not changed.

Menu overview (except ZB version)

Main Menu

Telephone Book		
	Name #1	Telephone book entry #1 is dialled
	To	To
	Name #50	Telephone book entry #50 is dialled
Change Telephone Book		
	New Entry	Add a new entry to the telephone book
	Change Entry	A telephone book entry is changed
	Delete Entry	A telephone book entry is deleted
	Delete All	The entire telephone book is deleted
Lock / PIN		
	Direct Call	
	Activate	The direct call is switched on
	Change Number	Change or enter the direct call number
	Total Lock	The telephone is locked completely
	Directory Only	Telephone is locked except for numbers in the telephone book
	Settings	The main menu items "Settings", "Languages" and "Change Phonebook" are disabled or enabled.
	Change PIN	The PIN is changed (default 0000)
Settings		
	Ringer	
	Volume	The ringer volume is set
	Melody	The ringer melody is set
	Speaker Volume	The loudspeaker volume is set durably
	Handset Volume	The handset volume is set durably
	Headset Volume	The headset volume is set durably
	LCD Contrast	The LCD contrast is set
	Dialling	
	DTMF 90ms	Sets the dialling method to DTMF 90 ms
	Pulse Dial 2.0 : 1	Sets the dialling method to PDM 2:1
	Pulse Dial 1.5 : 1	Sets the dialling method to PDM 1.5:1
	DTMF 70ms	Sets the dialling method to DTMF 70 ms
	DTMF	Sets the dialling method to DTMF unlimited
	Flash Time	Set the flash time to between 40 and 399 ms
	PABX Settings	
	Enter Exchange Code	Entry of an exchange number
	Clear Exchange Code	The exchange number is deleted
	Pause Exchange Code	Set dialling pause to between 1 and 6 s
	Defaults	Resets to the state when delivered and the telephone book is deleted
	Ext. Speaker	Switch on/off external loudspeaker
	Welcome text	change
Languages		
	German	Menu language German is activated
	English	Menu language English is activated
	Spanish	Menu language Spanish is activated
	French	Menu language French is activated
	Italian	Menu language Italian is activated

Technical data

Note:

Except for ZB version for items marked with an asterisk *).

Connection data	
Supply voltage	24 V _{DC} to 66 V _{DC}
Supply current	15 mA _{DC} to 100 mA _{DC}
Ringer voltage	24 V _{AC} to 90 V _{AC} (calling frequency 21...54 Hz) 30 V _{AC} to 90 V _{AC} (calling frequency 16.6...54 Hz)
Ringer impedance	Greater than 6.0 kΩ at 25 Hz and 24...90 V _{AC} . Greater than 4.0 kΩ at 50 Hz and 24...90 V _{AC} .
Consultation hold key *)	Flash function adjustable from 40 ms to 399 ms via the menu.
Dialling method *)	PD or DTMF mode can be set via the menu. DTMF mode in accordance with ITU-T recommendation Q.23. Pulse Dial mode with pulse pause ratio 1.5:1 or 2:1 (adjustable via the menu).
Exchange number*)	An exchange number and dialling pause are programmable to between 1 s and 6 s via the menu.
Bell-Shunt	Possibility for connecting a second external ringer.
External speaker	Terminals for the connection of an external speaker (optional accessory).
Headset *)	Terminals for the connection of a headset (optional accessory). Note: A headset or a second ear piece can be connected, but not both simultaneously !
Second ear piece	Terminals for the connection of a second ear piece (optional accessory). Note: A headset or a second ear piece can be connected, but not both simultaneously !
Connection terminals	Up to 4 mm ² inflexible. Up to 2.5 mm ² flexible.
Housing	
Material	Glass-fibre-reinforced polyester
Height x width x depth	approx. 260 mm x 228 mm x 135 mm
Weight	approx. 5.5 kg
Display *)	2-line alphanumeric display with pictograms. Field of view approx. 78 mm x 26 mm.
Keyboard *)	- Metal keyboard with protection against ice. - 21 keys with ABC inscription for name entries.

Position of operation	Mounted upright on the wall. The device must be mounted on a plane surface only.
Handset	
Sling protection	Integrated, adjustable sling protection.
Handset cord	Steel-reinforced steel-clad cord made of V4A.
Earphone	Dynamic capsule with stray-field coil for the inductive connection of hearing-aids.
Microphone capsule	Electret microphone
Noise suppression	Greater than 3 dB by integrated speak-in horn.
Ambient conditions	
Protection type:	IP 66 as per EN60529
Protection against external mechanical impacts	IK 09 as per EN50102
Operating temperature:	-25°C to +60°C (display does not operate below -20°C)
Storage temperature:	-25°C to +70°C as per IEC60721
Additional features	
Clearing key *)	Separate key
Hook switch	Dry reed contact without a mechanical cradle
Power supply	- from the analogue telephone network. - no additional mains supply required.
Meter-pulse lock	- Electrical attenuation for 12 kHz and 16 kHz on the earphone greater than 30 dB with respect to 1 kHz. - Impedance (telephone connections A, B): approx. 13 kΩ (1 V _{eff} ; 12 kHz ; idle state) approx. 4 kΩ (10 V _{eff} ; 12 kHz ; idle state) approx. 2.5 kΩ (1 V _{eff} ; 12 kHz ; during a call) approx. 2.3 kΩ (10 V _{eff} ; 12 kHz ; during a call) approx. 11 kΩ (1 V _{eff} ; 16 kHz ; idle state) approx. 4 kΩ (10 V _{eff} ; 16 kHz ; idle state) approx. 2.5 kΩ (1 V _{eff} ; 16 kHz ; during a call) approx. 2.3 kΩ (10 V _{eff} ; 16 kHz ; during a call)
Optical call *) signalling	Display indicates ((()))

Ringer volume	<ul style="list-style-type: none"> - approx. 95 dB(A) at a distance of 1 m at 50 V_{AC} / 50 Hz (In the default settings. The maximum volume is also dependent on the selected melody and on the power-supply conditions). - 6-step volume and mute mode can be set via the menu. (The ringer volume is reduced by approx. 13 dB(A) if the optional external loudspeaker is switched on in the menu).
Ringer melodies *)	10 melodies can be selected via the menu.
Open Listening	<ul style="list-style-type: none"> - Maximum volume approx. 70 dB(A) at a distance of 1 m - 7-step volume can be set via the menu. *) - Durable setting via the menu *) (The internal loudspeaker volume is reduced if the optional external loudspeaker is switched on in the menu).
Hands-free *)	<ul style="list-style-type: none"> - Function possible where ambient noise do not exceed 70 dB(A). (at greater noise levels, it is not possible to understand the telephone conversation in hands-free mode). - Maximum loudspeaker volume approx. 70 dB(A) at a distance of 1 m - 7-step volume can be set via the menu. - Durable setting via the menu (The open listening volume is reduced if the optional external loudspeaker is switched on in the menu).
Handset loud function *)	<ul style="list-style-type: none"> - Handset volume from 0 dB to +12 dB. - 7-step volume can be set via the menu. - Durable setting via the menu.
Menus *)	<ul style="list-style-type: none"> - In German, English, Spanish, French and Italian. - An audible signal is given if programming was successful.
Telephone book *)	- A maximum of 50 entries with name and telephone number.

Guidelines and regulations	
<p>Conformity to the following guidelines and regulations:</p>	<ul style="list-style-type: none"> - R&TTE Directive -1999/5 EG - Low Voltage Directive 73/23/EWG - EMC Directive RL89/336/EG for the domestic / residential and industrial areas - ETSI TBR 38: May 1998 (acoustics) - ETSI TBR 21: January 1998 (telephone-network access) but without device-internal DC limitation to 60 mA (see TBR21 item 4.7.1 DC characteristics) <p>Advisory notes ETSI EG 201 121 V1.1.2 (1998-07):</p> <ul style="list-style-type: none"> - ATAAB AN 003, 004, 013 relevant to all countries - ATAAB AN 005, 006, 007, 009, 010 and DE 03, 04,05, 08, 09, 12, 14, 17 for Germany - FTZ 121TR8: May 1994 Part 2.1 and 2.2 for the performance feature open listening - FTZ 121TR8: May 1994 Part 2.1, 2.2 and 3 for the performance feature hands-free talking - Pulse dialling method in accordance with BAPT 223 ZV5 version 07.96 (where dialling method PDM 1.5:1 is set) - Pulse dialling method in accordance with BS6305:1982 with change AMD 4558:1984 (where dialling method PDM 2:1 is set) - Meter-pulse lock for 12 kHz BAKOM 337/2.2:12/97 - Meter-pulse lock for 16 kHz in the general meaning of BAKOM 337/2.2:12 / 1997 - FTZ 121TR8: November1993 Part 3.1 for the magnetic field generator in the handset

Service

You have purchased a state-of-the-art product manufactured by **FHF** and subject to stringent quality controls. If you have questions regarding the telephone or if a malfunction has occurred – even after the guarantee period – please contact **FHF** (see page 4). Please have the type and article number ready (these numbers can be found on the type plate) when you contact us.

Maintenance and servicing

The telephone is maintenance-free. Nevertheless, if the telephone is deployed in areas with significant impurities due to dust, grease, oil etc., then it should be cleaned from time to time. The handset and the telephone should be wiped with a damp cleaning cloth. **Caution!** Never use sharp objects for cleaning.

Waste disposal

The device may be completely recycled as electronic waste. Upon disassembling the device, the plastic, metal and electronic components must be disposed of separately.

In every single case the national requirements and regulations for waste disposal must be observed.

The waste-disposal requirements of your country must be observed.

Warning and safety instructions

This equipment is a weather-resistant telephone specifically designed for operation in a harsh industrial environment. The following warning and safety instructions must be heeded:

1. The telephone is constructed in protection class II and must only be connected to and operated with the stipulated voltage. A proper connection must be ensured. The connection wire must be laid in such a manner that there is no danger of stumbling.
2. The telephone must only be operated under the specified ambient conditions (see section "Technical data"). Adverse ambient conditions, such as e.g. ambient temperatures which are too high or too low, are not permissible because this promotes the failure of electronic components.
3. It must be ensured that the telephone, the connection wire etc. are not damaged. It is not permissible to operate the telephone in a damaged state.
4. When operating the telephone, please heed the legal and commercial / industrial regulations, accident-prevention regulations and electrical regulations / provisions.
5. Repairs are only permissible with original spare parts which must be replaced by a specialist. Other replacement parts can cause damage and render the guarantee invalid.

6. Before repair is performed or before replacement of the telephone, it must be disconnected from the voltage supply. If it is unavoidable that the power be switched on during servicing or repair, then this must only be performed by suitably trained specialist personnel.
7. The stipulated position of utilisation must be adhered to. The telephone must be installed on a plane surface only, in vertical operating position.
8. In the open state of the telephone no dust may ingress the device.
9. Upon mounting or demounting the device, do not damage the cover seal, which keeps the cover tight, or the collar on the lower part of the housing.
10. Magnetic fields with energy technical frequencies can cause a slight impairment of the listening quality. If this is the case, please ensure that the telephone is installed at a suitable location.
11. If there is a high concentration of sulphurous gases in the environment, the lettering of the keys can fade and a rust film can arise.
12. Changes to the product which are in the interests of technical progress are possible even without prior notice.

CE symbol

The ResistTel fulfils the requirements of the R&TTE Directive - 1999/5 EG (Radio equipment and telecommunications terminal equipment and the mutual recognition of their conformity)

In detail the ResistTel complies with the Low Voltage Directive 73/23/EEG and the EMC Directive 89/336/EEG for the domestic / residential and industrial areas.

The conformity of the ResistTel with the above-mentioned directives is confirmed by the CE symbol.

Index of catchwords

Assembly	10	Maintenance and servicing	27
CE symbol.....	28	Main menu	16
Change telephone book	18	Menus	15
Complete lock	19	Menu overview.....	22
Connection diagram	11	Open Listening	13
Default settings	21	Overview of device	5
Direct call	19	Packing contents	9
Display and keyboard.....	8	Pause after exchange number	20
Display contrast	20	Pulse Dialling	20
Drilling diagram	12	Ringer melody	20
DTMF	20	Ringer volume	20
Exchange number	20	Second ear piece	11
External loudspeaker	10	Secondary ringer (Bell-shunt)	10
External Ringer (Bell-shunt).....	10	Service	27
Flash	20	Settings	20
Foreword	2	Sling holder.....	11
General operating instructions	4	Technical data	23
Hands-free talking	13	Telephone book	17
Handset mode	13	Warning and safety instructions.....	27
Handset volume	13	Welcome text	20
Headset	14	ZB version notes.....	9
Installation	10		
Languages	21		
Lock / PIN	19		
Loudspeaker volume	16		

Subject to change without notice



FHF Funke + Huster Fernsig GmbH

Gewerbeallee 15-19 · D-45478 Mülheim an der Ruhr
Phone +49/208/82 68-0 · Fax +49/208/82 68-286
<http://www.fhf.de> · e-mail: info@fhf.de